

Centre Number	Candidate Number	Name
---------------	------------------	------

UNIVERSITY OF CAMBRIDGE INTERNATIONAL EXAMINATIONS  
General Certificate of Education Ordinary Level

**COMBINED SCIENCE** **5129/02**

Paper 2 May/June 2004

**2 hours 15 minutes**

Candidates answer on the Question Paper.  
No Additional Materials are required.

**READ THESE INSTRUCTIONS FIRST**

Write your Centre number, candidate number and name on all the work you hand in.  
Write in dark blue or black pen in the spaces provided on the Question Paper.  
You may use a soft pencil for any diagrams, graphs, tables or rough working.  
Do not use staples, paper clips, highlighters, glue or correction fluid.

Answer **all** questions.  
The number of marks is given in brackets [ ] at the end of each question or part question.  
A copy of the Periodic Table is printed on page 20.

If you have been given a label, look at the details. If any details are incorrect or missing, please fill in your correct details in the space given at the top of this page.

Stick your personal label here, if provided.

<b>For Examiner's Use</b>	
<b>Total</b>	

1 (a) Both animal and plant cells contain a nucleus.  
State two other features found in

(i) animal cells,

1. ....

2. ....

(ii) plant cells.

1. ....

2. ....

[4]

(b) Fig. 1.1 shows a cell.

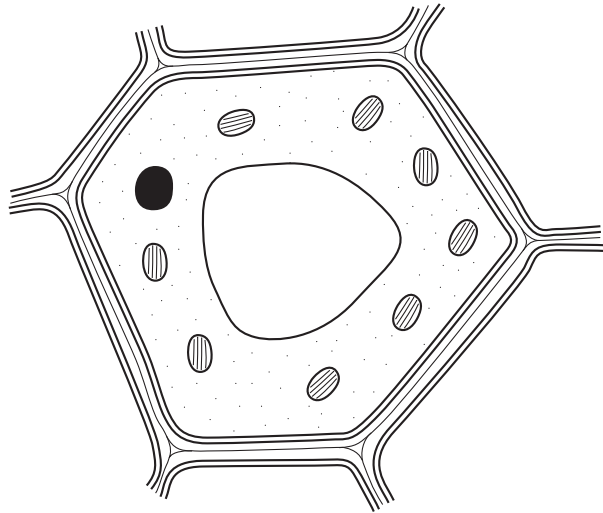

Fig. 1.1

State whether this is a plant cell or an animal cell.

.....[1]

2 Fig. 2.1 shows an extension – load graph for an elastic band.

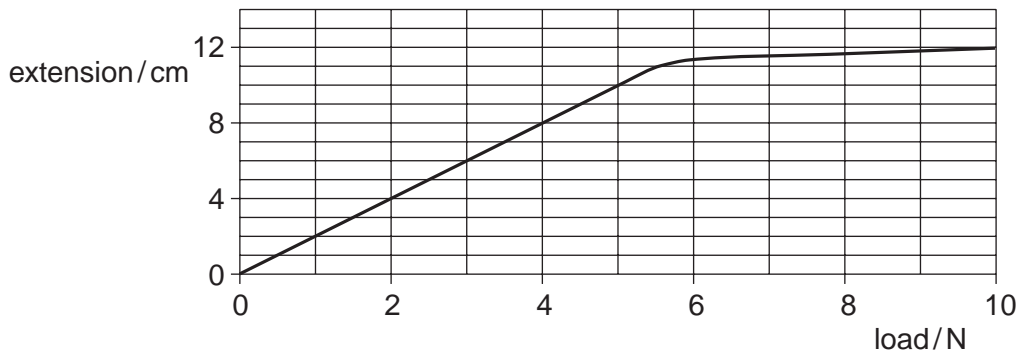

Fig. 2.1

(a) What load gives an extension of 5.0 cm? .....N [1]

(b) The length of the elastic band with no load is 8.0 cm.

What load gives the elastic band a length of 14.0 cm?

.....N [2]

(c) Draw a labelled diagram of the apparatus that may be used to obtain an extension – load graph for an elastic band.

[2]

3 Fig. 3.1 represents the particles in different substances at room temperature.

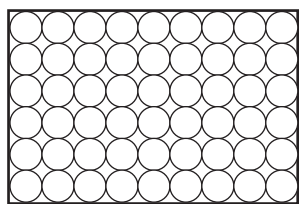

A

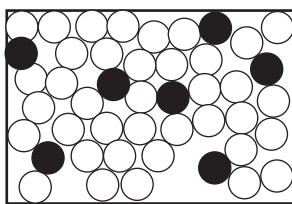

B

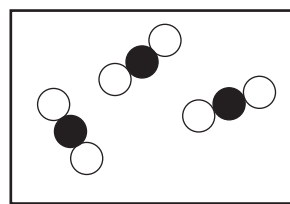

C

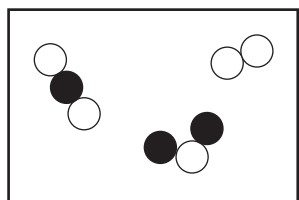

D

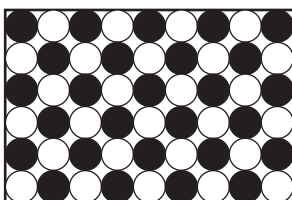

E

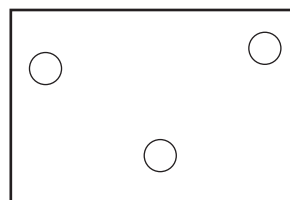

F

Fig. 3.1

Which diagram could represent

- (a) a gaseous element, .....
- (b) an alloy, .....
- (c) a gaseous mixture, .....
- (d) sodium chloride, .....
- (e) air? .....

[5]

- 4 Fig. 4.1 shows a ray of light from a pin. The light is incident on a plane mirror.

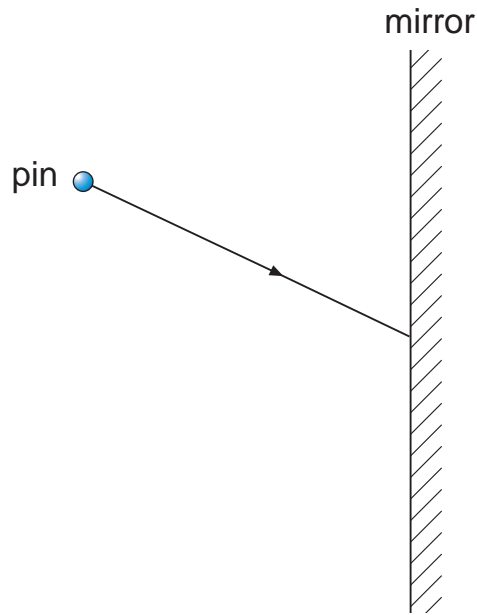

Fig. 4.1

- (a) On Fig. 4.1,

- (i) draw the reflected ray,  
(ii) mark with an **X** the position of the image of the pin.

[3]

- (b) Fig. 4.2 shows a ray of light passing from air into a glass block. The normal to the surface of the glass is shown.

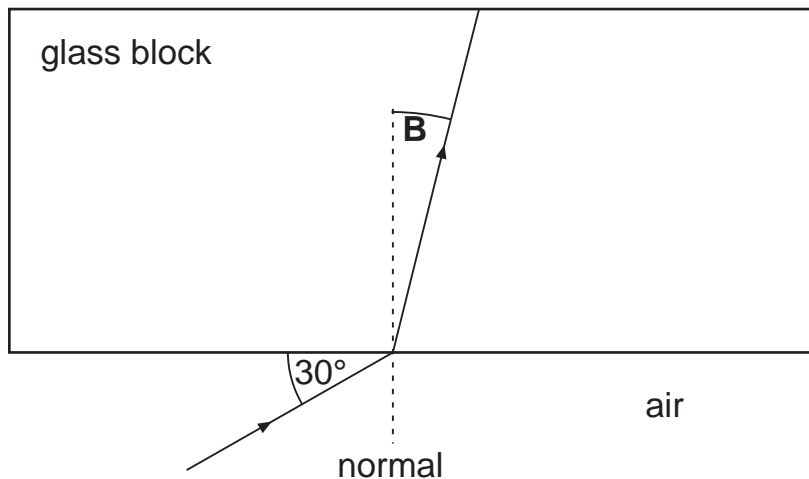
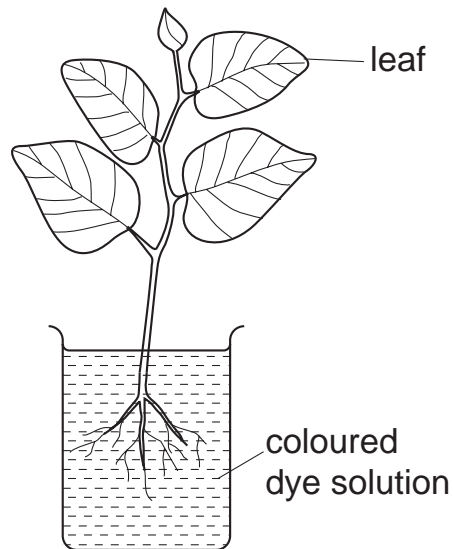

Fig. 4.2

- (i) Calculate the angle of incidence. ....  
(ii) Name angle **B**. ....

[2]

- 5 Fig. 5.1 shows a seedling with its roots in a coloured dye solution. The dye travels slowly up the stem to the leaves.



**Fig. 5.1**

- (a) After four hours, a section of one of the leaves is examined under a microscope.

Fig. 5.2 shows the section as seen under the microscope.

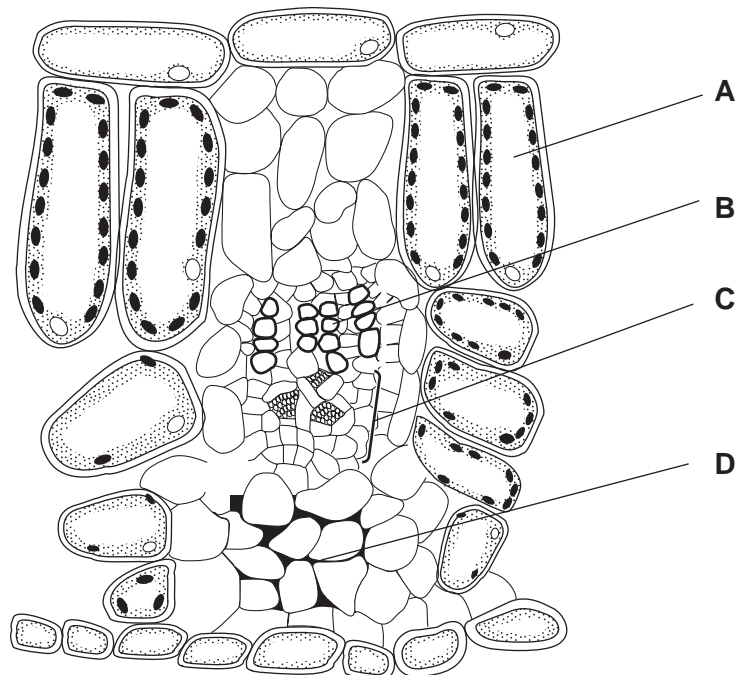

**Fig. 5.2**

- (i) In which region, **A**, **B**, **C** or **D** will the coloured dye be seen?

.....

- (ii) Name the tissue chosen in (a)(i).

..... [2]

**(b) (i)** Name the chemical process for which the leaf uses water.

.....

**(ii)** Suggest two other uses for water in a plant.

1. ....

2. ....

[3]

**(c)** A healthy seedling is growing in a sunny place, but there is not enough water around its roots.

**(i)** Describe how the appearance of the seedling changes after several hours.

.....

.....

.....

**(ii)** Explain why the changes in **(c)(i)** take place.

.....

.....

.....

[3]

- 6 Fig. 6.1 shows a balanced uniform metre rule. The knife edge is at the 50.0 cm mark and the 0.1 N weight is at the 20.0 cm mark.

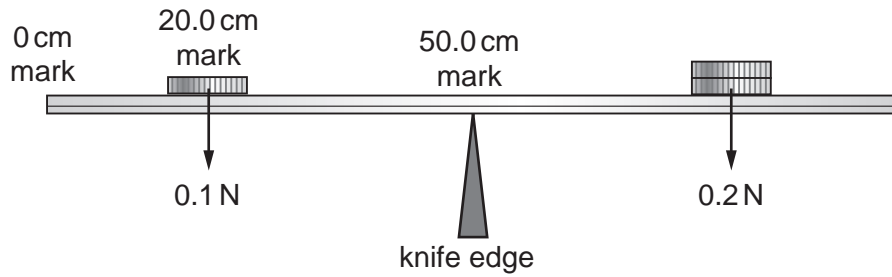

**Fig. 6.1**

- (a) Calculate the anticlockwise moment of the 0.1 N weight about the knife edge.

.....N cm [2]

- (b) Calculate the distance of the 0.2 N weight from the knife edge.

.....cm [2]



- 7 Fig. 7.1 shows a blast furnace for the extraction of iron from haematite,  $\text{Fe}_2\text{O}_3$ .

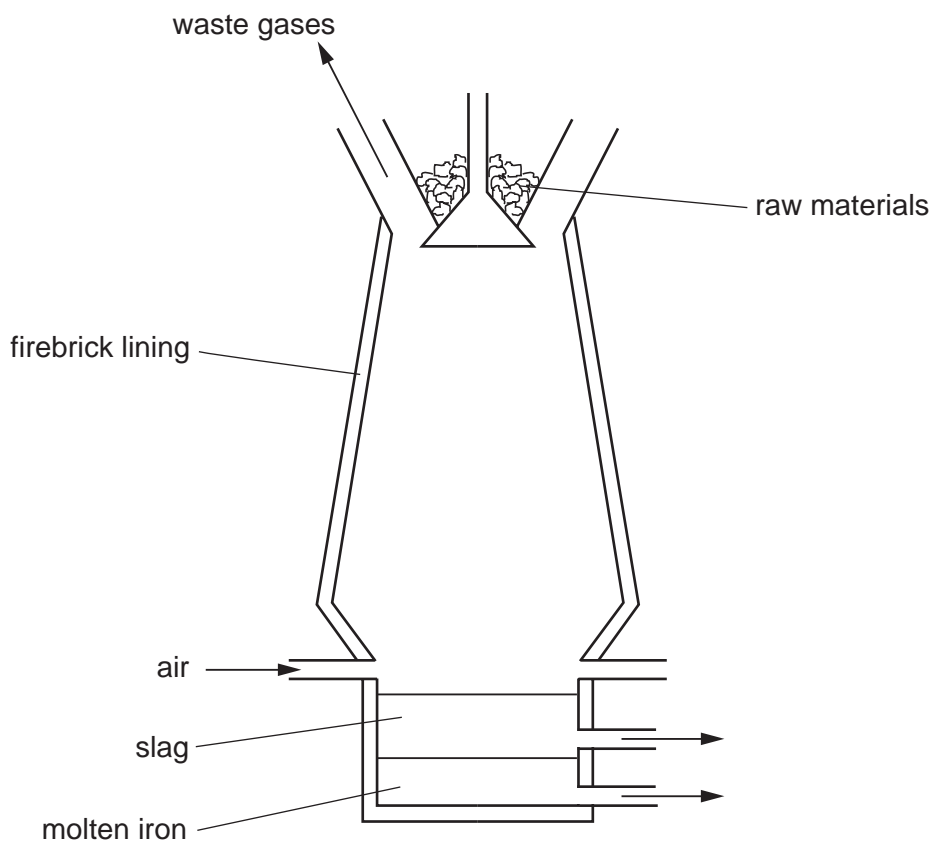
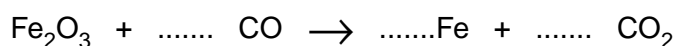

Fig. 7.1

- (a) Name the raw materials put in at the top of the blast furnace with the haematite.

..... and ..... [2]

- (b) (i) Balance the following equation for the reduction of haematite to iron.



- (ii) Carbon monoxide acts as a reducing agent in the reaction.  
Explain the meaning of the term *reducing agent*.

.....  
..... [2]

- (c) (i) Name the **two** substances that cause iron to rust.

..... and .....

- (ii) State what is meant by *galvanising* and explain how it prevents iron from rusting.

.....  
.....  
.....

[4]

8 Fig. 8.1 shows a longitudinal section through a blood vessel.

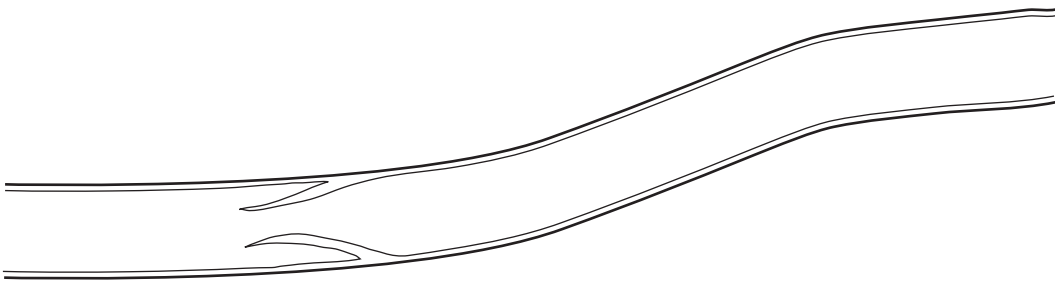

**Fig. 8.1**

**(a)** State whether Fig. 8.1 shows an artery or a vein and give a reason for your choice.

.....  
.....  
.....[1]

**(b)** State two other differences between arteries and veins.

1. ....  
.....  
2. ....  
.....[2]

- (c) Fig. 8.2 shows blood flowing towards the small intestine and away from it, during digestion of a meal.

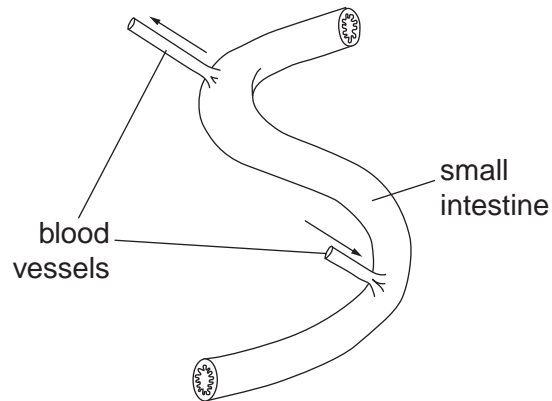

**Fig. 8.2**

The blood leaving the intestine has changed.  
State **one** change that has taken place in

- (i) the oxygen content of the blood,

.....

- (ii) the pressure of the blood,

.....

- (iii) the concentration of glucose dissolved in the blood.

.....

[3]

- 9 (a) Heat is transferred in solids by conduction. Explain how the molecules in a solid are involved in conduction.

.....  
.....[2]

- (b) Fig. 9.1 shows a convector heater in a room. This produces a convection current in the air in the room.

Draw arrows on Fig. 9.1 to show the directions of the flow of air in the room.

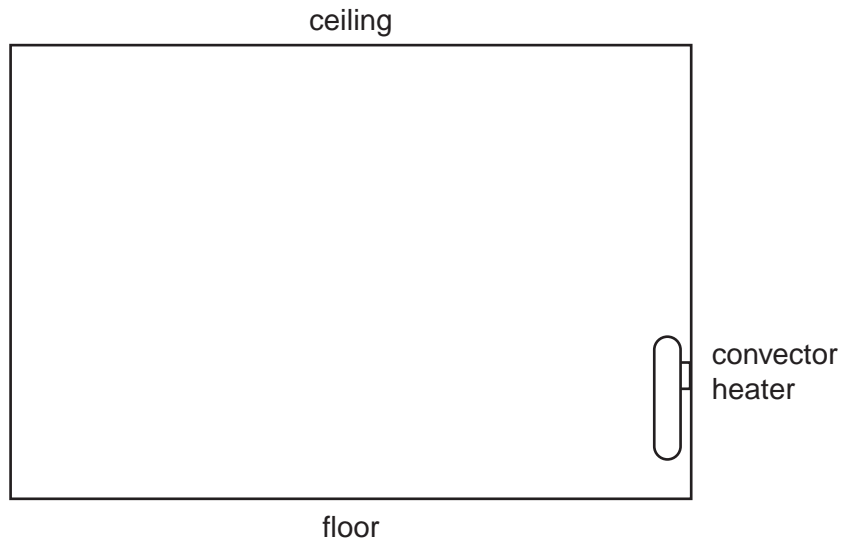

**Fig. 9.1**

[2]

- 10 Argon is an element in Group 0 of the Periodic Table. One isotope of argon is represented below.



- (a) How do isotopes of an element differ from one another?

.....  
.....[1]

- (b) How many neutrons are present in one atom of  ${}_{18}^{40}\text{Ar}$ ?

.....[1]

- (c) Explain why argon has no chemical reactions.

.....  
.....[2]

- (d) State **one** use of argon.

.....[1]

- 11 The ammeter in Fig. 11.1 reads 0.2 A.

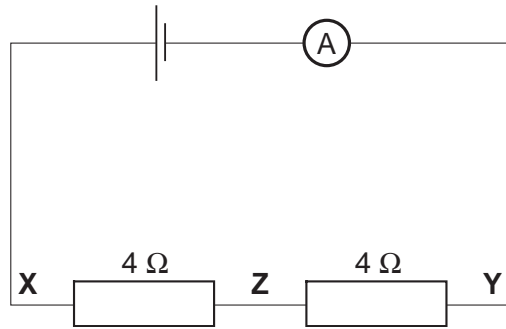

Fig. 11.1

(a) State the current at Z. ....[1]

(b) Calculate the potential difference between

(i) X and Z,

(ii) X and Y.

[3]

12 Fig. 12.1 shows the female reproductive system.

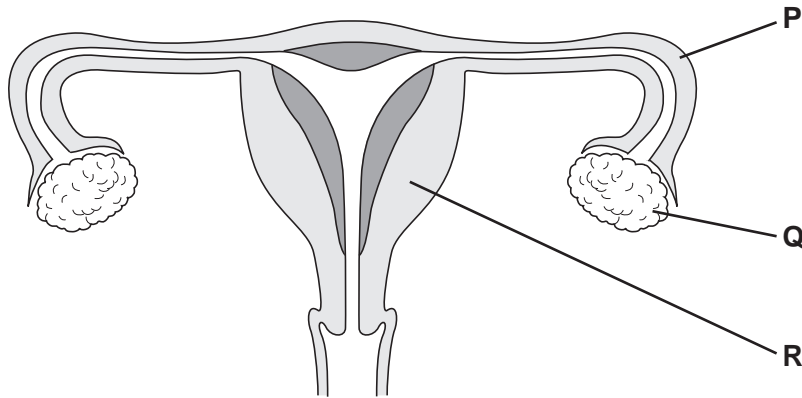

Fig. 12.1

(a) Name and state the function of the parts labelled P, Q and R.

**P** name.....  
 function.....

**Q** name.....  
 function.....

**R** name.....  
 function.....

[6]

(b) On Fig. 12.1

- (i) label with an **X** the place where sperm are deposited,
  - (ii) label with a **Y** where eggs are normally fertilised.
- [2]

(c) A woman begins to menstruate on July 1st.  
 When is the next date that she is likely to ovulate?

.....[1]

13 (a) State the difference between magnetic and non-magnetic materials.

.....[1]

(b) Insulated wire is wrapped round a core as shown in Fig. 13.1. A current is passed through the wire to form an electromagnet.

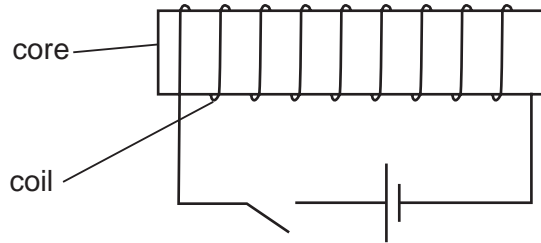

Fig. 13.1

(i) Suggest a suitable material for the core.

.....

(ii) State two ways by which the strength of the electromagnet may be increased.

1. ....

2. ....

[3]

14 (a) Name two gases that pollute the atmosphere.  
For each one, state a source of the pollutant.

gas 1 .....

source .....

.....

gas 2 .....

source .....

.....[4]

(b) Describe an effect of **one** of these gases on the environment.

.....

.....

.....[1]



15 Alpha-particles, beta-particles and gamma-rays are three types of radioactive emissions.

(a) State which type is

(i) the most penetrating, .....

(ii) the most ionising, .....

(iii) part of the electromagnetic spectrum. ....

[3]

(b) State what is meant by the *half-life* of a radioactive material.

.....

.....[2]

(c) A radioactive material emits beta-particles. Fig. 15.1 shows the number of beta-particles emitted in one second at two different times.

time/hours	number of particles emitted in one second
0	400
24	100

**Fig. 15.1**

Calculate the half-life of the radioactive material.

[2]

- 16 The first member of the alkene homologous series is ethene.  
Ethene,  $C_2H_4$ , is an unsaturated hydrocarbon.

(a) Explain what is meant by *unsaturated*.

.....  
.....[1]

(b) State the general formula of the alkenes.

.....[1]

(c) Ethanol,  $C_2H_5OH$ , can be produced by reacting ethene with steam.

(i) State **one** condition required for this reaction.

.....

(ii) Deduce the equation for the reaction.

.....  
[2]

(d) Ethene undergoes polymerisation to form poly(ethene).  
Draw the structure of the polymer molecule.

[2]

17 (a) Name the products of digestion of protein.

.....[1]

(b) Suggest two uses of protein in the body.

1. ....

.....

2. ....

.....[2]

(c) Some molecules from the digestion of protein are not used by the body. They are changed into urea.

(i) In which organ does this change occur?

.....

(ii) What happens to the urea that is formed?

.....

.....

[2]

18 Study the following reaction scheme.

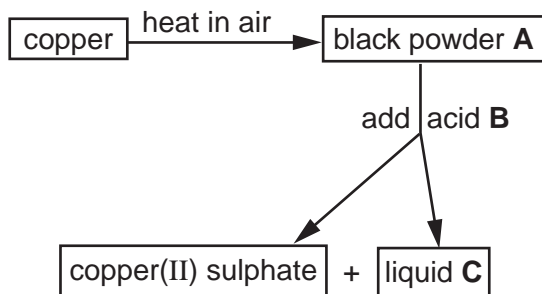

(a) Identify substances **A**, **B** and **C**.

black powder **A** .....

acid **B** .....

liquid **C** .....[3]

(b) Liquid **C** has a pH value of 7.  
What is the colour of Universal Indicator in this liquid?

.....[1]

(c) What type of reaction does copper undergo when heated in air?

.....[1]

