



Cambridge IGCSE™

CANDIDATE
NAME

CENTRE
NUMBER

--	--	--	--	--

CANDIDATE
NUMBER

--	--	--	--

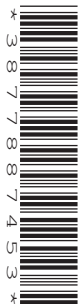

PHYSICS

0625/61

Paper 6 Alternative to Practical

May/June 2022

1 hour

You must answer on the question paper.

No additional materials are needed.

INSTRUCTIONS

- Answer **all** questions.
- Use a black or dark blue pen. You may use an HB pencil for any diagrams or graphs.
- Write your name, centre number and candidate number in the boxes at the top of the page.
- Write your answer to each question in the space provided.
- Do **not** use an erasable pen or correction fluid.
- Do **not** write on any bar codes.
- You may use a calculator.
- You should show all your working and use appropriate units.

INFORMATION

- The total mark for this paper is 40.
- The number of marks for each question or part question is shown in brackets [].

This document has **12** pages. Any blank pages are indicated.

- 1 A student investigates the stretching of a spring.

The apparatus is shown in Fig. 1.1.

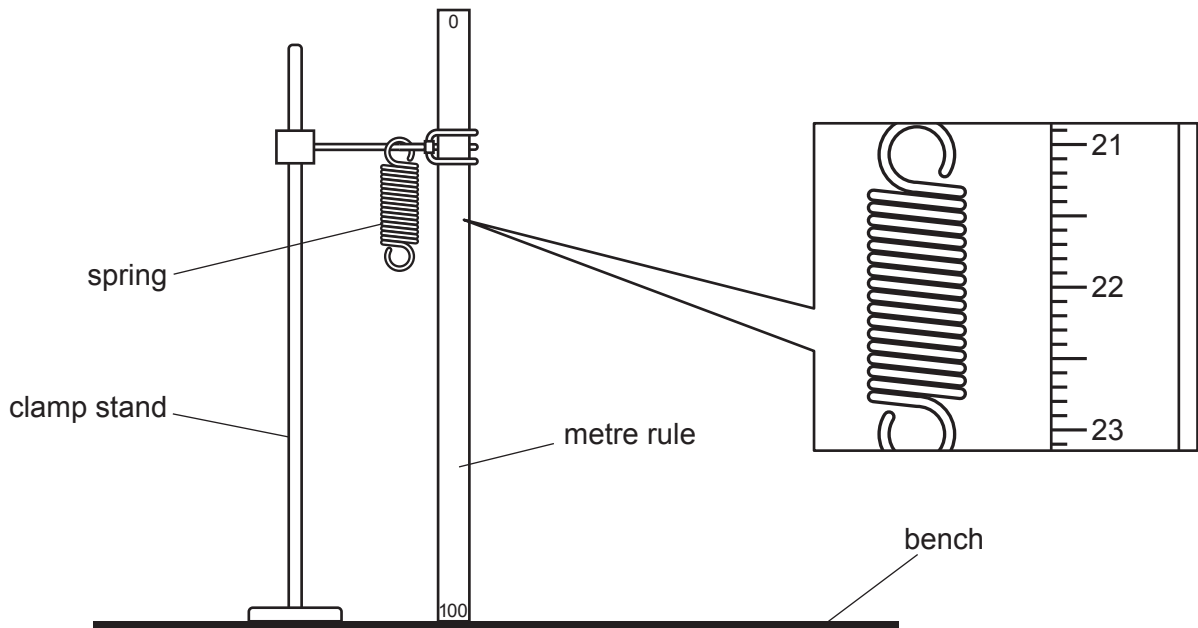

Fig. 1.1

- (a) (i) On Fig. 1.1, take two readings from the metre rule to determine the unstretched length l_0 of the coiled part of the spring.

reading 1 cm

reading 2 cm

$l_0 =$ cm
[3]

- (ii) Draw a diagram to show clearly how you would use a set square to obtain an accurate reading from the metre rule.

[1]

- (b) The student suspends a load of $P = 1.0\text{ N}$ from the spring.

He records the new length l_1 of the coiled part of the spring.

$$l_1 = \dots\dots\dots 2.2 \dots\dots\dots \text{cm}$$

Calculate the extension e_1 using the equation $e_1 = (l_1 - l_0)$.

$$e_1 = \dots\dots\dots \text{cm}$$

Calculate a value for the spring constant k of the spring using the equation

$$k = \frac{P}{e_1}.$$

Include the unit.

$$k = \dots\dots\dots [2]$$

- (c) The student suspends a load of $P = 5.0\text{ N}$ from the spring.

He records the new length l_5 of the coiled part of the spring.

$$l_5 = \dots\dots\dots 6.3 \dots\dots\dots \text{cm}$$

Calculate the extension e_5 using the equation $e_5 = (l_5 - l_0)$.

$$e_5 = \dots\dots\dots \text{cm}$$

Calculate a second value for the spring constant k of the spring using the equation

$$k = \frac{P}{e_5}.$$

Give your answer to two significant figures.

$$k = \dots\dots\dots [2]$$

- (d) State whether your two values of the spring constant k can be considered equal within the limits of experimental accuracy.

Explain your answer by referring to your results.

statement

explanation

.....

.....

[1]

- (e) A student improves the experiment by taking additional sets of readings.

- (i) Suggest the additional apparatus that the student uses.

.....

..... [1]

- (ii) Suggest how the student uses the additional results.

.....

..... [1]

[Total: 11]

2 A student investigates the cooling of water.

The apparatus is shown in Fig. 2.1.

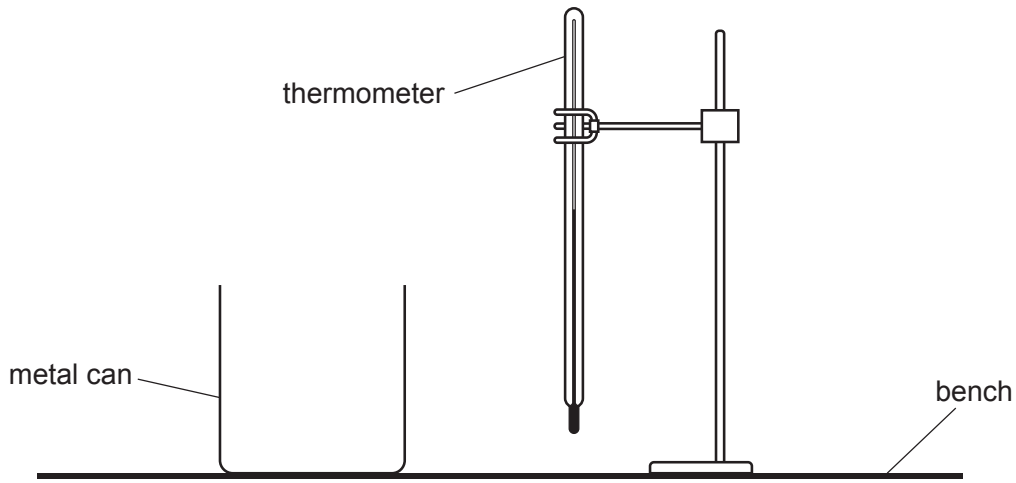

Fig. 2.1

(a) The thermometer in Fig. 2.2 shows the room temperature θ_R at the beginning of the experiment. Record θ_R .

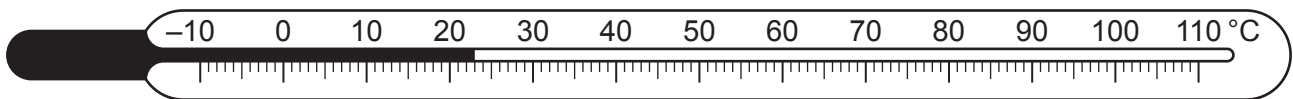

Fig. 2.2

$\theta_R = \dots\dots\dots$ [1]

(b) The student pours hot water into the metal can.

She places the thermometer in the hot water.

She records the temperature θ of the hot water at time $t = 0$ and immediately starts a stop-clock.

She measures the water temperature every 30s. The readings are shown in Table 2.1.

Complete the column headings in Table 2.1.

Table 2.1

$t/$	$\theta/$
0	84
30	79
60	75
90	72
120	70
150	68
180	67

[1]

- (c) The student pours the water from the can into a measuring cylinder and records the volume V of water.

$$V = \dots\dots\dots 196 \dots\dots\dots \text{cm}^3$$

- (i) State **two** precautions taken when reading the volume of water in a measuring cylinder in order to obtain an accurate result.

1.

2.

[2]

- (ii) The student records the volume V to the nearest 1 cm^3 .

Suggest why this is appropriate.

.....

..... [1]

- (d) (i) Calculate the decrease in temperature $\Delta\theta_1$ of the hot water between times $t = 0$ and $t = 60 \text{ s}$.

$$\Delta\theta_1 = \dots\dots\dots$$

Calculate the average rate of cooling R_1 of the water using the equation

$$R_1 = \frac{\Delta\theta_1}{\Delta t},$$

where $\Delta t = 60 \text{ s}$. Include the unit.

$$R_1 = \dots\dots\dots [2]$$

- (ii) Calculate the decrease in temperature $\Delta\theta_2$ of the hot water between times $t = 120 \text{ s}$ and $t = 180 \text{ s}$.

$$\Delta\theta_2 = \dots\dots\dots$$

Calculate the average rate of cooling R_2 of the water using the equation

$$R_2 = \frac{\Delta\theta_2}{\Delta t},$$

where $\Delta t = 60 \text{ s}$. Include the unit.

$$R_2 = \dots\dots\dots [1]$$

- (e) A student suggests that the rate of cooling is lower when the temperature of the water is lower.

State and explain whether the results support this suggestion.

.....
.....
..... [1]

- (f) The student states that most of the thermal energy lost by the water in the can is by evaporation from the water surface.

Another student states that most of the thermal energy lost by the water in the can is by conduction through the sides of the can.

The students repeat the experiment twice to investigate the two statements.

Suggest **one** suitable addition to the apparatus for **each** additional experiment.

1.
2. [2]

[Total: 11]

- 3 A student investigates the resistance of a wire.

Fig. 3.1 shows the circuit he uses.

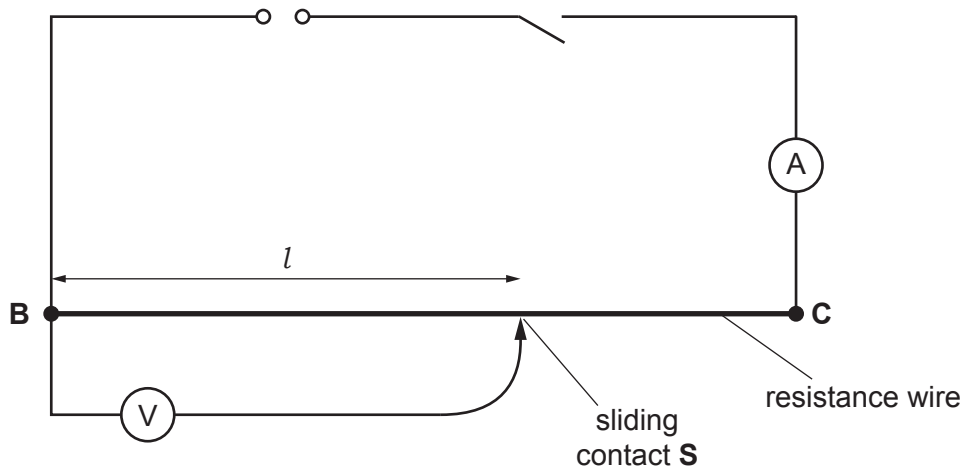

Fig. 3.1

- (a) The student measures the current and decides that he wants to use a lower current.

He adds a variable resistor to the circuit to reduce the current.

On Fig. 3.1, mark with an **X** a suitable position in the circuit for the variable resistor. [1]

- (b) The student measures the current I in the circuit.

Record the current shown in Fig. 3.2.

$I = \dots\dots\dots$ [1]

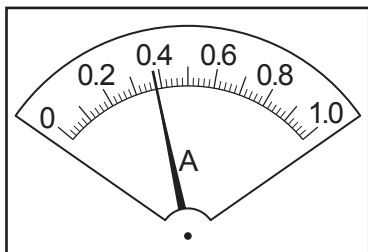

Fig. 3.2

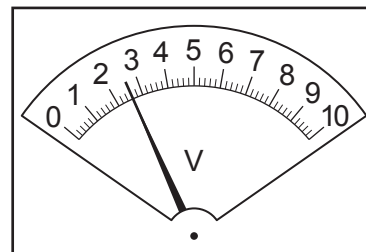

Fig. 3.3

- (c) The student places the sliding contact at a distance $l = 85.0$ cm from **B**.

He measures, and records in Table 3.1, the potential difference (p.d.) V across the length l of resistance wire **BC**.

Record, in Table 3.1, the potential difference shown in Fig. 3.3. [1]

(d) The student repeats the procedure using l values of 65.0 cm, 45.0 cm, 25.0 cm and 5.0 cm. His readings are shown in Table 3.1.

(i) Calculate, and record in Table 3.1, the resistance R of 85.0 cm of the resistance wire using the equation

$$R = \frac{V}{I} \quad [1]$$

(ii) Complete the column headings in Table 3.1.

Table 3.1

l/cm	V/I	$R/$
5.0	0.2	0.53
25.0	0.8	2.11
45.0	1.4	3.68
65.0	2.0	5.26
85.0		

[1]

(e) Plot a graph of resistance R (y -axis) against length l (x -axis). Start both axes at the origin (0,0).

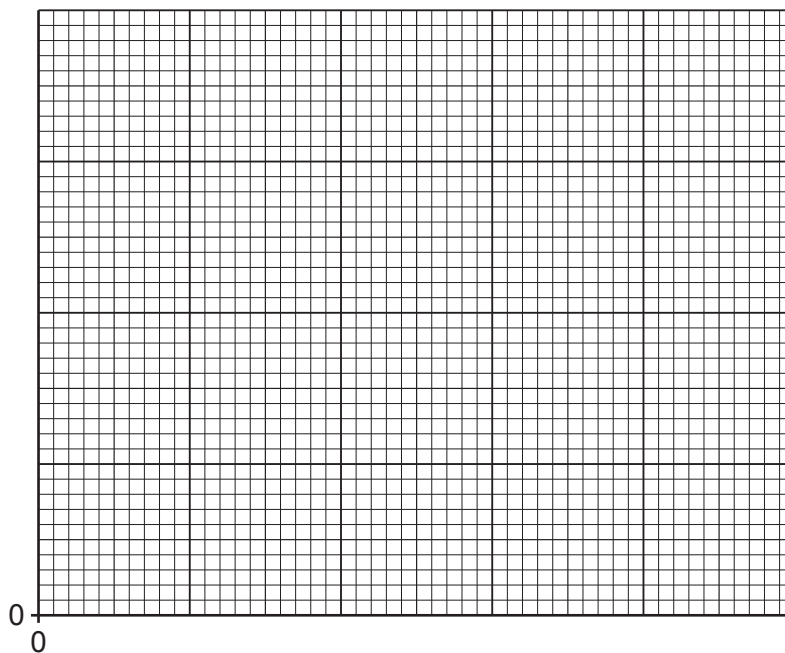

[4]

(f) Use your graph to determine the resistance R_{50} of 50.0 cm of the resistance wire.

Show clearly on the graph how you obtained the necessary information.

$$R_{50} = \dots\dots\dots [2]$$

[Total: 11]

- 4 A student investigates the force required to break different beams made from a mixture of sand and cement. All the beams have the same cross-section.

Plan an experiment to investigate the force required to break the beams.

Fig. 4.1 shows the set-up.

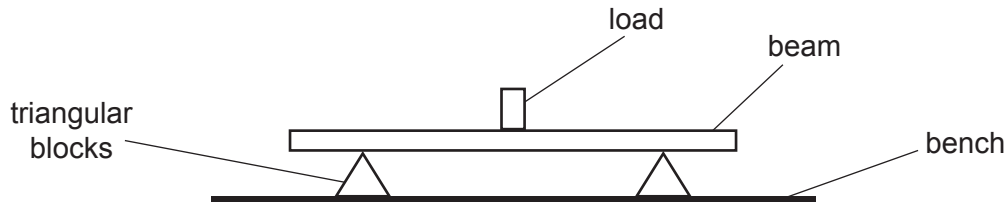

Fig. 4.1

The following apparatus is available:

- a selection of beams made from different ratios of sand and cement and of various lengths
- triangular blocks to support the beams
- a metre rule
- a selection of loads.

You can also use other apparatus and materials that are usually available in a school laboratory.

The student takes all the necessary safety precautions. You are **not** required to write about safety precautions.

In your plan, you should:

- explain briefly how to carry out the investigation (you may add to the diagram if it helps your explanation)
- state the key variables to keep constant
- draw a table, or tables, with column headings, to show how to display your readings (you are **not** required to enter any readings in the table)
- explain how you would use the readings to reach a conclusion.

BLANK PAGE

Permission to reproduce items where third-party owned material protected by copyright is included has been sought and cleared where possible. Every reasonable effort has been made by the publisher (UCLES) to trace copyright holders, but if any items requiring clearance have unwittingly been included, the publisher will be pleased to make amends at the earliest possible opportunity.

To avoid the issue of disclosure of answer-related information to candidates, all copyright acknowledgements are reproduced online in the Cambridge Assessment International Education Copyright Acknowledgements Booklet. This is produced for each series of examinations and is freely available to download at www.cambridgeinternational.org after the live examination series.

Cambridge Assessment International Education is part of Cambridge Assessment. Cambridge Assessment is the brand name of the University of Cambridge Local Examinations Syndicate (UCLES), which is a department of the University of Cambridge.